



# Sign, Display & Road Traffic Materials Product Guide

 EXPERTISE  COLLABORATION  INTEGRITY



## Righton Blackburns is an independent metals and plastics stockholder with more than a century of trusted supply-chain expertise.

Today, we are recognised as a leading supplier to a diverse customer base. Our commitment to quality and service enables us to meet requirements ranging from sign & display to road traffic materials.

Our reputation is founded on both the efficiency and integrity of our business dealings, as well as our proven ability to innovate and respond to change.

A unique supplier of metals and plastics we operate from nine strategically located Service Centres across the UK, delivering exceptional product quality and outstanding service to customers nationwide.

With our focus on customer service, technical expertise, modern facilities and reliable logistics, we respond efficiently and effectively to every requirement.

In addition, our central facility carries over 10,000 tonnes of material in 200,000 square feet of warehouse space, helping us provide immediate stock availability and remain responsive to the constant fluctuations in demand faced by industry today.

Committed to building long term relationships with our customers we have made significant investment in fabrication and processing facilities, allowing us to supply material closer to final form, creating a real opportunity for a one-stop shop.

As a trusted supply partner, we are committed to the ethical sourcing and delivery of our products and services. Our long-term focus on responsible, low-impact operations is driving measurable reductions in our carbon footprint, aligning with our broader environmental priorities and supporting the transition to a more responsible, lower-carbon future.

# Your trusted supply partner

## for quality metals and specialist plastics

### Righton Blackburns are market leaders for the supply of component parts to the commercial and traffic sectors.

With a comprehensive range of sign components and 'semi fabrication' options, sign makers are able to choose between buying individual components such as aluminium painted sheet, rails or posts as separate items, or in kit form with bespoke fabrication to the customers finished requirements.

Righton Blackburns has the ability to produce bespoke sign trays or cassettes and intricate shape signs for external and internal purposes.

PVC FOAM	2	ALUMINIUM RAILS	16
CAST ACRYLIC	4	ALUMINIUM TEE SECTIONS	17
ALUMINIUM COMPOSITE	6	ALUMINIUM ROUND & SQUARE POSTS	18
POLYCARBONATE	8	STEEL ROUND & SQUARE POSTS	19
PETG	9	BUCKLE SYSTEMS	20
POLYPROPYLENE FLUTED PANEL	10	STAINLESS STEEL BANDING SYSTEMS	21
STEEL COLOR®	10	STAINLESS STEEL CLIP SECTIONS	22
SIGN KITS, FRET WORK & BESPOKE SIGNS, COMPOSITE SIGN TRAYS	11	ALUMINIUM OFFSET BRACKETS	23
ROAD TRAFFIC SIGN PRODUCTS	12	COMPLETE SMALL OFFSET BRACKET ASSEMBLIES	23
ALOCHROMED & PAINTED SHEET	13	COMPLETE LARGE OFFSET BRACKET ASSEMBLIES	23
ALUMINIUM CIRCLES, TRIANGLES, OCTAGONS	14		
BCP TRAFFIC COMPOSITE SHEET, BCP TEMPORARY	15		

## PVC Foam

PVC foam provides the optimum surface finish for all types of processing in the sign, display and print industries, accepting any form of graphic overlay including screen print, digital print direct and vinyl lamination.

### FOAMALUX & FOAMALUX LITE - MATT FINISH

A material that is versatile, lightweight, fire retardant, durable and with a flawless finish. Offering unlimited options for the sign, display and print industries. For large format digital print customers, printing direct to substrate, bright white PVC foam sheet helps deliver a higher level of reflection from the surface for printed colours that appear more vibrant with sharp, well defined image definition.

### KOMAPRINT DIGI FOAM

Developed specifically for the needs of the printing industry, KomaPrint Digital Foam is an innovative material, with special properties for the perfect coverage of all printing and display design requirements. The finely textured surface and the shining white material present the perfect base for an excellent printed image. This shows to advantage, particularly in digital and screen printing as well as laminations.

KomaPrint Digi Foam is recommended by Righton Blackburns for the best printing results. For display design, the combination of the fine celled structure and highly stabilising makeup makes KomaPrint a durable, yet lightweight material. It is moisture-resistant, and equally suitable for indoor and outdoor applications. Whether series or custom production, punching, trimming, sawing, or cutting, KomaPrint offers the best product properties for a wide range of further processing options.

### FOAMALUX ULTRA - GLOSS FINISH

For endless applications in the sign, display and fabrication industries. Few other materials are as versatile or can be transformed in so many ways, bringing on a third dimension to this flat sheet product.

### FOAMALUX XTRA

Manufactured from recycled foam PVC recovered from production and post consumer signage waste, Foamalux Xtra PVC is the cost effective green alternative. It comprises of a recycled black core, sandwiched between one or two surfaces of premium quality virgin white PVC, providing the optimum surface for any sign and display application. Containing up to 80% recycled content Foamalux Xtra is the environmentally friendly sign and display solution.

## CELUKA FOAM SHEET

A rigid yet lightweight foam sheet with a hard, high quality finish and excellent working properties. This integral foam sheet is an excellent replacement material for wood based products, with extremely safe fire performance to BS476/7 Class 1.

Celuka sheets are suitable for use in many different applications, as with free foamed PVC, including advertising, display structures, cladding, lining and more.

FOAMALUX PVC FOAM SHEET						KOMAPRINT	CELUKA	
	White Matt	White Gloss	Black Matt	XTRA		White Lite	DIGI FOAM SHEET	FOAM SHEET*
				Black 1 Side White 1 Side	Black 2 Sides Black Core			
SIZE (mm)	SHEET THICKNESS (mm)							
2440 x 1220	1, 2, 3, 4, 5, 10, 13, 19, 24	3, 5, 10	3, 5, 10	3, 5	-	2, 3, 4, 5, 6, 8, 10	2, 3, 4, 5, 6, 8, 10	10
3000 x 1200	-	-	-	-	-	-	-	13
3050 x 1220	3, 5, 10, 24	-	-	-	-	-	-	19
3050 x 1560	19	-	19	-	10	2, 3, 5, 10	2, 3, 5, 10	-
3050 x 2050	3, 5, 10	-	3, 5, 10	-	-	2, 3, 4, 5, 6, 8, 10	2, 3, 4, 5, 6, 8, 10	-

\* Other sizes available upon request

## Cast Acrylic

### CRYLUX® CAST ACRYLIC

A highly versatile material with exceptional transparency, durability and UV stability cast acrylic is suitable for both interior applications. With a hard, high gloss surface and exceptional mechanical properties combined with a wide range of colours and finishes, cast acrylic sheet offers the user utility as well as decoration. Readily fabricated and formed using conventional tools and equipment, cast acrylic sheets are the ideal thermoplastic sheet material for signage and point of sale and LED designs.

Available in clear, opal, white and black cast acrylic is a perfect choice when a visual impact is required.

Our range of cast acrylic opals, available in all industry standard tints and light transmissions are optimised for back-lit lighting applications whilst also providing a clean, bright appearance during daylight hours when the product is not illuminated.

### CRYLON® EXTRUDED ACRYLIC

Crylon® is the most versatile of sheet materials. Its high transparency and durability make it an excellent choice for applications where appearance is important. A UV stable product, which is perfect for both outside signage and many internal usages such as POS and display features, it is available in a range of coloured finishes. Crylon® high-impact strength can be used for more demanding applications.

### MIRRORED ACRYLIC

The perfect material for many applications including POS, sign making, motor homes and refrigeration end panels. Available in 2440 x 1220 x 3mm.

SHEET SIZE (mm)	CLEAR LT	OPAL 050 (4005) LT 37%	WHITE 069 (3014) LT 5%	BLACK (3945) LT <1%
2440 x 1220 x 3	■			
2440 x 1220 x 4	■			
2440 x 1220 x 5	■			
2440 x 1220 x 6	■			
2440 x 1220 x 8	■			
2440 x 1220 x 10	■			
3050 x 2030 x 2	■			
3050 x 2030 x 3	■			
3050 x 2030 x 4	■			
3050 x 2030 x 5	■			
3050 x 2030 x 6	■			
3050 x 2030 x 8	■			
3050 x 2030 x 10	■			
3050 x 2030 x 12	■			
3050 x 2030 x 15	■			
3050 x 2030 x 20	■			
3050 x 2030 x 25	■			
3050 x 2050 x 3		■	■	■
3050 x 2050 x 5		■	■	■
3050 x 2050 x 6				■
3050 x 2050 x 10		■	■	■

Other colours available upon request

## Aluminium Composite























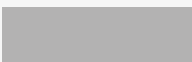















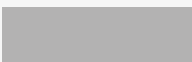









### ALUCOBEST®

Alucobest® aluminium composite sheet is the ideal material for almost any decorative application including signage, point of sale, exhibition stands, displays, interior cladding, portable buildings, kiosks, boat interiors and hoarding. A lightweight, extremely flat and rigid material, aluminium composite sheet is also durable, versatile and easy to use. The high quality finish polyester coating makes it an ideal substrate for printing.

Our range includes white, colours and special finishes including mirrors, dual metallic, galvanised steel and brushed metallic silvers.

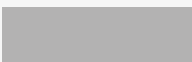
STANDARD FINISH	SIZE (mm)	SKIN (mm)
WHITE (Gloss / Matt UV Paint)	2500 x 1250 x 3	0.21
	2500 x 1250 x 3	0.30
	3050 x 1500 x 3	0.21
	3050 x 1500 x 3	0.30
	4050 x 1500 x 3	0.30
	3050 x 2000 x 3	0.30
	4050 x 2000 x 3	0.30
WHITE (Matt / Mill UV Paint)	2440 x 1220 x 3	0.12
	2440 x 1220 x 3	0.15
	2440 x 1220 x 3	0.18
	2500 x 1250 x 3	0.18
	3050 x 1500 x 3	0.15
BLACK (RAL 9005) (Gloss / Matt)	3050 x 1500 x 3	0.21
	2500 x 1250 x 3	0.21

SPECIAL FINISH	COLOUR	SIZE (mm)	SKIN (mm)
INTERNAL MIRROR	Silver / Mill	2440 x 1220 x 3	0.30
	Silver / Mill	3050 x 1220 x 3	0.30
	Gold / Mill	2440 x 1220 x 2	0.30
GALVANISED STEEL / MAGNETIC	White / Mill	2440 x 1220 x 3	0.35
DUAL METALLIC	Gold/Bronze	3050 x 1500 x 3	0.30
	Champagne / Metallic Silver	3050 x 1500 x 3	0.30
DUAL METALLIC (UV Paint)	Light Grey / Dark Grey	3050 x 1500 x 3	0.21
	Light Bronze / Dark Bronze	3050 x 1500 x 3	0.21

COLOURS - ALUMINIUM COMPOSITE SHEET																																	
Aluminium Features	Al-Mn Alloy Series 1100 Sheet Thickness 0.3mm * also available in 0.21mm																																
Panel Surface	Gloss / Matt																																
Standard Sizes (mm) (RAL colours)	<table border="1"> <tr> <td>2500 x 1250 x 3 (3020)</td> <td>2500 x 1250 x 3* (9005)</td> </tr> <tr> <td>3050 x 1500 x 3 (3020)</td> <td>3050 x 1500 x 3* (9005)</td> </tr> <tr> <td>2500 x 1250 x 3 (1003)</td> <td>3050 x 2000 x 3 (9005)</td> </tr> <tr> <td>3050 x 1500 x 3 (1003)</td> <td>2500 x 1250 x 3 (6005)</td> </tr> <tr> <td>2500 x 1250 x 3 (5002)</td> <td>3050 x 1500 x 3 (6005)</td> </tr> <tr> <td>3050 x 1500 x 3 (5002)</td> <td>2500 x 1250 x 3 (7015)</td> </tr> <tr> <td>3050 x 1500 x 3 (5017)</td> <td>3050 x 1500 x 3 (7015)</td> </tr> <tr> <td>2500 x 1250 x 3 (1015)</td> <td>2500 x 1250 x 3 (2004)</td> </tr> <tr> <td>3050 x 1500 x 3 (1015)</td> <td>3050 x 1500 x 3 (2004)</td> </tr> <tr> <td>2500 x 1250 x 3 (7024)</td> <td>2500 x 1250 x 3 (8017)</td> </tr> <tr> <td>3050 x 1500 x 3 (7024)</td> <td>3050 x 1500 x 3 (8017)</td> </tr> <tr> <td>2500 x 1250 x 3 (3004)</td> <td>2500 x 1250 x 3 (9006)</td> </tr> <tr> <td>3050 x 1500 x 3 (3004)</td> <td>3050 x 1500 x 3 (9006)</td> </tr> </table>	2500 x 1250 x 3 (3020)	2500 x 1250 x 3* (9005)	3050 x 1500 x 3 (3020)	3050 x 1500 x 3* (9005)	2500 x 1250 x 3 (1003)	3050 x 2000 x 3 (9005)	3050 x 1500 x 3 (1003)	2500 x 1250 x 3 (6005)	2500 x 1250 x 3 (5002)	3050 x 1500 x 3 (6005)	3050 x 1500 x 3 (5002)	2500 x 1250 x 3 (7015)	3050 x 1500 x 3 (5017)	3050 x 1500 x 3 (7015)	2500 x 1250 x 3 (1015)	2500 x 1250 x 3 (2004)	3050 x 1500 x 3 (1015)	3050 x 1500 x 3 (2004)	2500 x 1250 x 3 (7024)	2500 x 1250 x 3 (8017)	3050 x 1500 x 3 (7024)	3050 x 1500 x 3 (8017)	2500 x 1250 x 3 (3004)	2500 x 1250 x 3 (9006)	3050 x 1500 x 3 (3004)	3050 x 1500 x 3 (9006)						
2500 x 1250 x 3 (3020)	2500 x 1250 x 3* (9005)																																
3050 x 1500 x 3 (3020)	3050 x 1500 x 3* (9005)																																
2500 x 1250 x 3 (1003)	3050 x 2000 x 3 (9005)																																
3050 x 1500 x 3 (1003)	2500 x 1250 x 3 (6005)																																
2500 x 1250 x 3 (5002)	3050 x 1500 x 3 (6005)																																
3050 x 1500 x 3 (5002)	2500 x 1250 x 3 (7015)																																
3050 x 1500 x 3 (5017)	3050 x 1500 x 3 (7015)																																
2500 x 1250 x 3 (1015)	2500 x 1250 x 3 (2004)																																
3050 x 1500 x 3 (1015)	3050 x 1500 x 3 (2004)																																
2500 x 1250 x 3 (7024)	2500 x 1250 x 3 (8017)																																
3050 x 1500 x 3 (7024)	3050 x 1500 x 3 (8017)																																
2500 x 1250 x 3 (3004)	2500 x 1250 x 3 (9006)																																
3050 x 1500 x 3 (3004)	3050 x 1500 x 3 (9006)																																
Standard Colours Sheet Thickness 3mm  2mm / 4mm Thickness available in White only  We can colour match to any RAL number, Pantone number or sample provided In either gloss or matt to specified gloss levels.  Minimum quantity order 600m <sup>2</sup> of paint.	<table border="1"> <tr> <td></td> <td></td> <td></td> <td></td> </tr> <tr> <td>Red RAL 3020</td> <td>NHS Blue RAL 5017</td> <td>Burgundy Red RAL 3004</td> <td>Slate Grey RAL 7015</td> </tr> <tr> <td></td> <td></td> <td></td> <td></td> </tr> <tr> <td>Yellow RAL 1003</td> <td>Cream RAL 1015</td> <td>Black RAL 9005</td> <td>Orange RAL 2004</td> </tr> <tr> <td></td> <td></td> <td></td> <td></td> </tr> <tr> <td>Blue RAL 5002</td> <td>Graphite Grey RAL 7024</td> <td>Racing Green RAL 6005</td> <td>Brown RAL 8017</td> </tr> <tr> <td></td> <td></td> <td></td> <td></td> </tr> <tr> <td>White Aluminium RAL 9006</td> <td>Mirror Polished Silver</td> <td>Mirror Polished Gold</td> <td>White</td> </tr> </table>					Red RAL 3020	NHS Blue RAL 5017	Burgundy Red RAL 3004	Slate Grey RAL 7015					Yellow RAL 1003	Cream RAL 1015	Black RAL 9005	Orange RAL 2004					Blue RAL 5002	Graphite Grey RAL 7024	Racing Green RAL 6005	Brown RAL 8017					White Aluminium RAL 9006	Mirror Polished Silver	Mirror Polished Gold	White
																																	
Red RAL 3020	NHS Blue RAL 5017	Burgundy Red RAL 3004	Slate Grey RAL 7015																														
																																	
Yellow RAL 1003	Cream RAL 1015	Black RAL 9005	Orange RAL 2004																														
																																	
Blue RAL 5002	Graphite Grey RAL 7024	Racing Green RAL 6005	Brown RAL 8017																														
																																	
White Aluminium RAL 9006	Mirror Polished Silver	Mirror Polished Gold	White																														

NOTE: Colours may vary due to monitor settings (PDF) / CMYK percentages (print)

## COLOUR BANDED PANELS

Colour banded panels have the colour bands running the length of the product, one side only. The reverse side can have standard paint or mill finish. Panels are available in standard widths: 1220mm, 1250mm, 1500mm and 2000mm with band widths between 50mm - 1900mm. These panels are manufactured to customer specified length and the number and widths of colour bands. Panels can be supplied in 3 standard paints: Polyester, FEVE or PVDF and gloss and matt colour bands can be mixed on one side. All colour bands are manufactured to customer supplied RAL numbers. Protective film in clear or white can also be selected by the customer.

## Polycarbonate

For durability and design freedom, polycarbonate is a modern material ideal for a diverse range of glazing applications for schools, bus and smoking shelters, canopies and machine guards or encapsulation projects.

Polycarbonate is the ideal safety glazing material where clarity, impact resistance and fire performance are critical requirements. Able to absorb high levels of energy, with an impact resistance 200 times that of glass, at half the weight, polycarbonate sheet is the ideal product for use both indoors and out, including commercial buildings subject to more demanding regulation or where there is a high risk of potential damage.

### MARLON FSX - LONGLIFE

A superior glazing solution to that of other materials, particularly when safety or impact resistance is of vital importance. Clearly transparent, the sheet maximises the light transmission when required and through tints can also offer solar control. The strength of polycarbonate is now legendary with unbeatable impact resistance, yet it still remains flexible enough to be cold bent on site for curved applications. With enhanced weather resistance and performance, longlife sheet can be used in the world's toughest climate conditions.

### MARLON FSX HARD

With an innovative protective coating, this sheet offers enhanced resistance to marks and scratches on applications exposed to airborne dust or dirt.

### MIRRORED POLYCARBONATE

Ideal for applications requiring the impact resistance of polycarbonate particularly in public buildings such as schools, hospitals, prisons, leisure centres and equestrian centres.

MARLON POLYCARBONATE SHEET			
	FSX CLEAR UV	FSX CLEAR PATTERN	FSX HARD
SIZE (mm) SHEET	THICKNESS (mm)		
2440 x 1220	3, 4, 5, 6, 8, 10		
3000 x 2000			4, 6
3050 x 2050	2, 3, 4, 5, 6, 8, 10, 12	3, 4, 6	

## PETg

With a range of colours and thicknesses, VIVAK PETg Sheets offer almost unlimited freedom of design when making three dimensional parts.

Shorter production times and less material wastage when creating complex forms help to save time and keep cost down.

### VIVAK® COPOLYESTER SHEET

These sheets create flowing, dream-like shapes. They are especially light, weather resistant, highly transparent, break and impact-resistant - even at low temperatures. These sheets are easily printable and highly suitable for food-contact applications. They can easily be thermoformed, so energy consumption is low, and productivity is high.

### VIVAK® THERMOFORMABLE SHEET

This plastic sheet is available in a variety of thicknesses and colours, and combine superior thermoforming properties with very good mechanical characteristics. Vivak® sheets can be thermoformed into any shape.

VIVAK® CLEAR SHEET
3050 x 2050 x 3mm
3050 x 2050 x 4mm
3050 x 2050 x 5mm
3050 x 2050 x 6mm
3050 x 2050 x 8mm
3050 x 2050 x 10mm

Other sizes available upon request

## Polypropylene Fluted Panel

Polypropylene is the ideal printing medium. Its double-sided Corona treatment allows easy printing, even for digital print. Polypropylene is resistant to moisture, it is strong and still very light. This makes Polypropylene the perfect substrate for outside and inside applications. The Corona treatment also provides a better adhesion when gluing the sheets to other materials, or when using adhesives.

### POLYPROPYLENE FLUTED PANEL

- can be cut or die-cut into virtually any shape.
- is available in a variety of colours.
- is extruded from polypropylene copolymer, it is much more durable than cardboard and is completely recyclable.

WHITE POLYPROPYLENE FLUTED PANEL
2440 x 1220 x 4mm
2440 x 1220 x 5mm
2440 x 1220 x 6mm
2440 x 1220 x 10mm
3050 x 1500 x 5mm
3050 x 1500 x 10mm

Other sizes available upon request

## Steel Color®

Righton Blackburns are the sole UK distributor of Steel Color® - Italy's leading stainless steel specialists in both the INCO and PVD colour process.

Enabling stainless steel to be offered in a vast range, Steel Color® sheets feature brilliant colours including silver, satinising finishes, embossed patterns and etched textures combining to create a product with options limited only by imagination.

A performance material with different grades formulated for different applications, stainless steel is well known to guarantee permanence, provide hygienic qualities and have outstanding durability, while satisfying all mechanical and thermal requirements.

Steel Color® has a variety of applications and is ideal for use in architectural interior applications for urban design.

For further information on the full range of colours and sizes available  
please contact your local service centre

## Sign Kits

### OFFSITE MANUFACTURING SERVICE

With supply of our unitised sign systems or sign kits, we offer our sign trade customers a manufacturing service to allow them to concentrate on the added value of sign design and installation.

Produced under quality controlled factory conditions, this robust range of signs can be sourced incorporating an aluminium composite sign tray, square or round posts with finials available in white and grey from stock or mill finish for subsequent painting to customer specification. With complementary accessories and simple assembly, these low maintenance sign kits provide a complete solution which should also help reduce delivery lead times to the end customer.

## Fret Work & Bespoke Signs

### INCREASED CAPACITY AND QUICKER LEAD TIMES

Righton Blackburns have invested heavily in developing the sign manufacturing element of its business, with the introduction of the new XYZ Router to complement our existing machines, this has enabled an increase in capacity, offering quicker lead times with the facility to cut specific and bespoke sizes, fret work lettering and shapes to our customers immediate requirements. Manufactured from the full range of sign making materials, such as BCP composite sheet, cast acrylic and polycarbonate.

Sign trays are a large part of the business and we can manufacture many different sizes, along with cutting a variety of shapes including Triangles, Circles, Rectangles, Octagons and Hexagons from the full range of materials.

## Composite Sign Trays

### COMPOSITE TRAY SIGNS MADE TO ORDER

Righton Blackburns in-house service manufactures composite panel into return-edge signs. Sign channels can be attached using the blind rivet system.



**RIGHTON  
BLACKBURNS**  
METALS AND PLASTICS

# Road Traffic Signs

Righton Blackburns extensive range of traffic signs and components are available in a variety of colours and finishes. Our nationwide network of service centres will deliver direct to your door, from raw materials to semi-fabricated products.

Please contact your local service centre to discuss your requirements or email [signs@rblimited.co.uk](mailto:signs@rblimited.co.uk)

## Alochromed & Painted Sheet

FINISH	SIZE
Grey 1 side	6' x 3' x 11swg
	6' x 4' x 11swg
	8' x 4' x 11swg
	10' x 4' x 11swg
	10' x 5' x 11swg
	2438mm x 600mm x 11swg
	3048mm x 600mm x 11swg
	2100mm x 1525mm x 11swg
	2500mm x 1250mm x 1.5mm
	2438mm x 1219mm x 2.5mm
Grey 2 sides	6' x 3' x 11swg
	8' x 4' x 11swg
	10' x 5' x 11swg
Grey back with white front	6' x 3' x 11swg
	6' x 4' x 11swg
	8' x 4' x 11swg
	2100mm x 1525mm x 11swg
	2438mm x 1219mm x 2.5mm
	10' x 5' x 11swg
Grey back with black front	8' x 4' x 11swg
Black 1 side	6' x 3' x 11swg
	6' x 4' x 11swg
	8' x 4' x 11swg
	10' x 5' x 11swg
Alochromed only (all sizes can be Alochromed)	8' x 4' x 11swg
	10' x 5' x 11swg
	2500mm x 1250mm x 1.5mm
White 1 side	2500mm x 1250mm x 0.7mm
	2500mm x 1250mm x 1.0mm
	2500mm x 1250mm x 1.5mm
	2500mm x 1250mm x 1.8mm
	2500mm x 1250mm x 2.0mm
	3000mm x 1250mm x 1.5mm
	3000mm x 1500mm x 1.5mm
	8' x 4' x 11swg
	Silver anodised sheet
2500mm x 1250mm x 1.5mm	
2500mm x 1250mm x 2mm	
2500mm x 1250mm x 3mm	

Processing facilities are available to cut to customised finished sizes.

All sizes can be supplied with fixing rails attached using the blind riveting system.

Sheets are available in other colours and sizes on request.

## Aluminium Circles

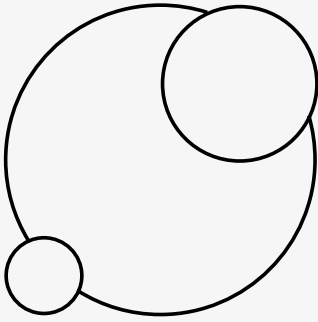

SIZE	PAINTED GREY (BS 381C/693)	PAINTED BLACK (RAL 9005)	PAINTED GREY (WITH RAIL ATTACHED) by Bollhoff System	PAINTED BLACK
300mm	■	■	■	■
450mm	■	■	■	■
600mm	■	■	■	■
750mm	■	■	■	■
900mm	■	■	■	■
1200mm	■	■	■	■
1500mm	■	■	■	■

Other sizes available upon request

## Aluminium Triangles

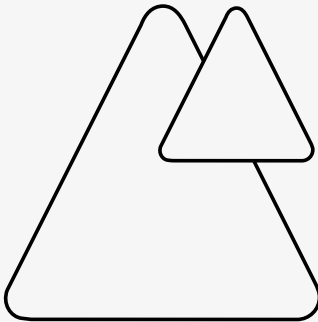

SIZE	PAINTED GREY (BS 381C/693)	PAINTED BLACK (RAL 9005)	PAINTED GREY (WITH RAIL ATTACHED) by Bollhoff System	PAINTED BLACK
600mm	■	■	■	■
750mm	■	■	■	■
900mm	■	■	■	■
1200mm	■	■	■	■
1500mm	■	■	■	■

Other sizes available upon request

## Aluminium Octagons

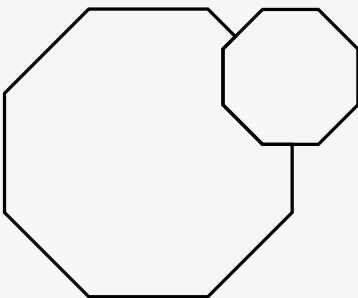

SIZE	PAINTED GREY (BS 381C/693)	PAINTED BLACK (RAL 9005)	PAINTED GREY (WITH RAIL ATTACHED) by Bollhoff System	PAINTED BLACK
600mm	■	■	■	■
750mm	■	■	■	■

Other sizes available upon request

TO BS EN 12889/1-2007  
REGULATIONS

All Aluminium blanks can be supplied with Sign Channels attached using a blind rivet system.

**BCP CIRCLES (DIAMETER) - STANDARD ROAD TRAFFIC SIZES**

300mm

450mm

600mm

750mm

900mm

1200mm

Other sizes available upon request

**BCP TRIANGLES (VERTICAL HEIGHT) - STANDARD ROAD TRAFFIC SIZES**

600mm

750mm

900mm

Other sizes available upon request

**BCP TRAFFIC****SIZE****SKIN**

2000 x 1000 x 3mm

0.5mm



8' x 4' x 3mm

0.5mm



10' x 5' x 3mm

0.5mm

Meeting BS EN 12889/1-2007 Regulations

**BCP TEMPORARY****SIZE****SKIN**

8' x 4' x 3mm

0.21mm



10' x 5' x 3mm

0.21mm

Other sizes available upon request

## BCP Traffic Composite Sheet

APPROVED for  
Permanent Road Signs  
with full 12 year warranty

## BCP Temporary

# Aluminium Rails

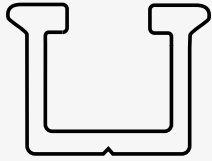

SMALL RAIL

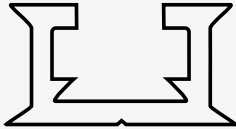

SMALL FLANGED RAIL

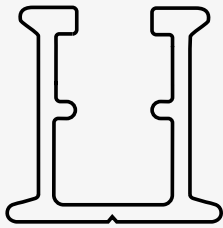

MEDIUM RAIL

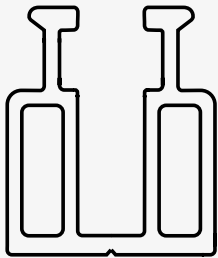

LARGE BOLLHOFF RAIL

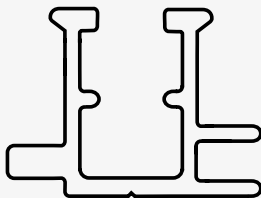

MEDIUM INTERLOCK

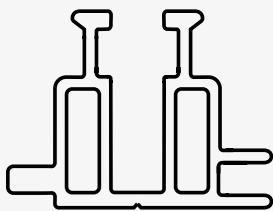

LARGE INTERLOCK

LENGTH	PAINTED GREY (BS 381C/693)	PAINTED BLACK (RAL 9005)	PAINTED WHITE (RAL 9016)	MILL FINISH
3000mm 5000mm	■ ■	■ ■	■ ■	■ ■
5000mm	■	■		■
3000mm 5000mm 6000mm	■ ■ ■	■ ■ ■	■	■ ■ ■
6000mm	■	■		
5000mm 6000mm	■ ■	■ ■		
6000mm	■	■		

LENGTH	PAINTED GREY (BS 381C/693)	PAINTED BLACK (RAL 9005)	PAINTED WHITE (RAL 9016)	MILL FINISH
3000mm	■	■	■	■
5000mm	■	■	■	■
3000mm	■	■	■	■
5000mm	■	■	■	■

## Aluminium Tee Sections

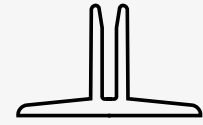

SMALL TEE SECTION

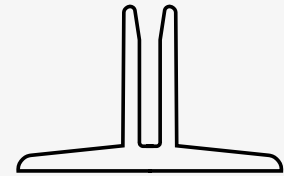

LARGE TEE SECTION

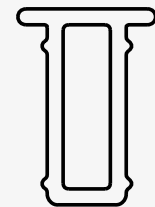

HOLLOW TEE

### HOLLOW TEE (Expands Large and Large Interlock Aluminium Rails)

Allows the length of Large and Large Interlock Aluminium Rails (p16) to be increased by connecting two pieces of sign channel.

The Hollow Tee component is inserted inside the Aluminium rail and another piece attached - Ideal for signs exceeding 6 metres in length.



For information on our range of Offset Brackets and Complete Offset Bracket Assemblies, please see Page 23.

### SUPPORT & SIGN STIFFENING CD

Righton Blackburns offer a Signload Program for Support and Sign Stiffening to BS EN 12889/1-2007 (System Requirements: Windows 2000, XP and Vista)

For further details please contact your nearest service centre.

(see back cover for locations and contact details...)

## Aluminium Round Posts

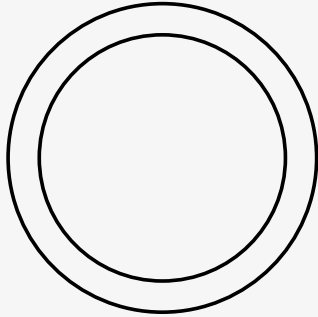

SIZE Ø	PAINTED WHITE (RAL 9016)	PAINTED GREY (BS 381C/693)	ANODISED SILVER (AA25)	MILL FINISH
50mm	■	■	■	■
76mm	■	■	■	■
89mm	■	■	■	■

Other sizes available upon request

Available in 3m to 6m lengths.

A full range of post caps and base plates are also available with prices on request.

Standard RAL Colours to order.

## Aluminium Square Posts

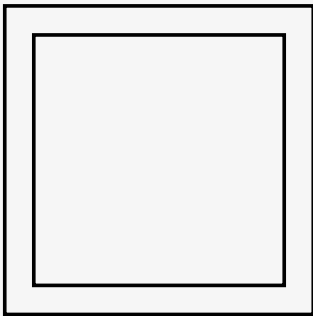

SIZE	PAINTED WHITE (RAL 9016)	PAINTED GREY (BS 381C/693)	PAINTED BLACK (RAL 9005)	MILL FINISH
50 x 50mm	■	■	■	■
76 x 76mm	■	■	■	■
100 x 100mm	■		■	■

Available in 3m to 6m lengths.

Aluminium Square Posts can also be Anodised Silver on request.

A full range of post caps and base plates are also available with prices on request.

Standard RAL Colours to order.

SIZE Ø	PAINTED RAL 7037	GALVANISED
50mm	■	■
60mm	■	■
76mm	■	■
89mm	■	■
114mm	■	■
140mm	■	■
168mm	■	■
197mm	■	■
219mm	■	■

Available from 3m lengths upwards.

A full range of stainless steel clips, post caps and base plates are also available with prices on request.

SIZE	PAINTED RAL 7037
Available on request	■

Available from 3m lengths upwards.

A full range of stainless steel clips, post caps and base plates are also available with prices on request.



## Steel Round Posts

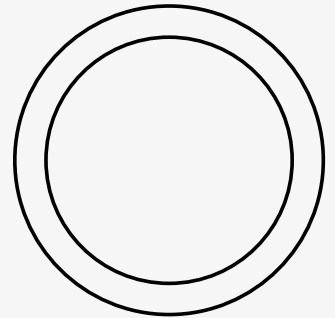

## Steel Square Posts

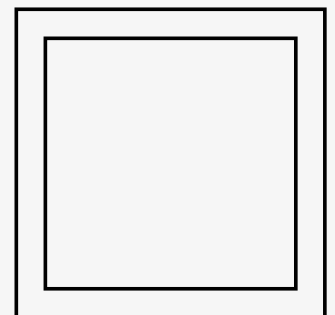

# Buckle Systems

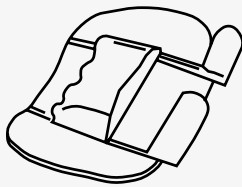
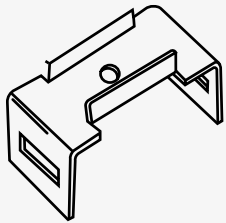
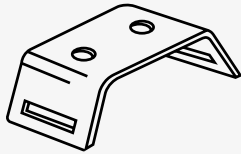
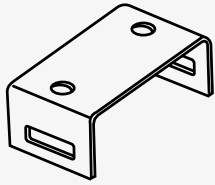

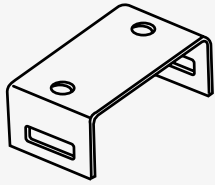
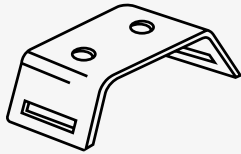
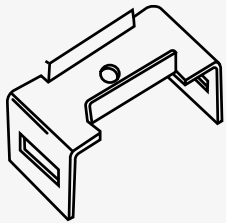
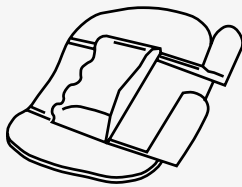
BUCKLE SYSTEMS	
	TYPE 1 BUCKLE
	TYPE 2 BUCKLE
	TYPE 3 BUCKLE
	STANDARD BUCKLE 1/2" Wide 3/4" Wide

Buckles are sold in quantities of 100



## BANDING SYSTEMS

## CHANNEL CLAMPS

## 1/2" WIDE SCREW BAND BUCKLE STRAPS

16" Lengths

18" Lengths

24" Lengths

36" Lengths

44" Lengths

## BANDING

Banding is available in:

1/2" x 100ft Coils

3/4" x 100ft Coils

## 1/2" WIDE BUCKLE STRAPS

18" Lengths

26" Lengths

36" Lengths

44" Lengths

## 3/4" WIDE BUCKLE STRAPS

18" Lengths

26" Lengths

36" Lengths

44" Lengths

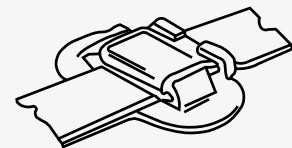
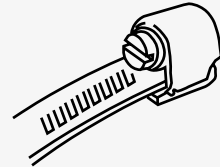
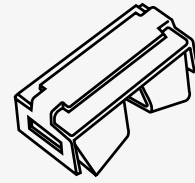
Stainless Steel  
Banding Systems

## Stainless Steel Clip Sections

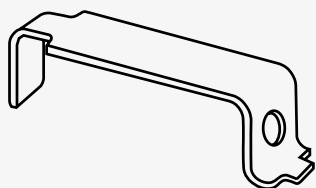

BACK TO BACK CLIPS

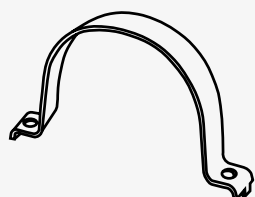

TWO BOLT CLIPS

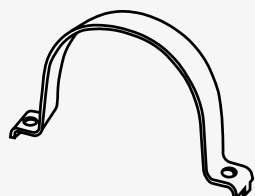

TWO BOLT  
HEAVY DUTY 'D' CLIPS



TWO BOLT MINI 'D' CLIPS

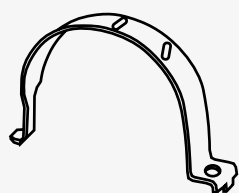

ONE PIECE CLIPS

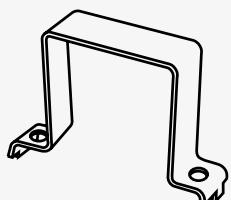

SQUARE &  
RECTANGULAR CLIPS

SIZE Ø	
	50mm
	60mm
	76mm
	89mm
	114mm
	127mm
	50mm
	60mm
	76mm
	89mm
	114mm
	140mm
	168mm
	194mm
	219mm
	244mm
	13mm
	16mm
	19mm
	25mm
	50mm
	60mm
	76mm
	89mm
	114mm
	50 x 50mm
	76 x 76mm
	80 x 80mm
	100 x 100mm

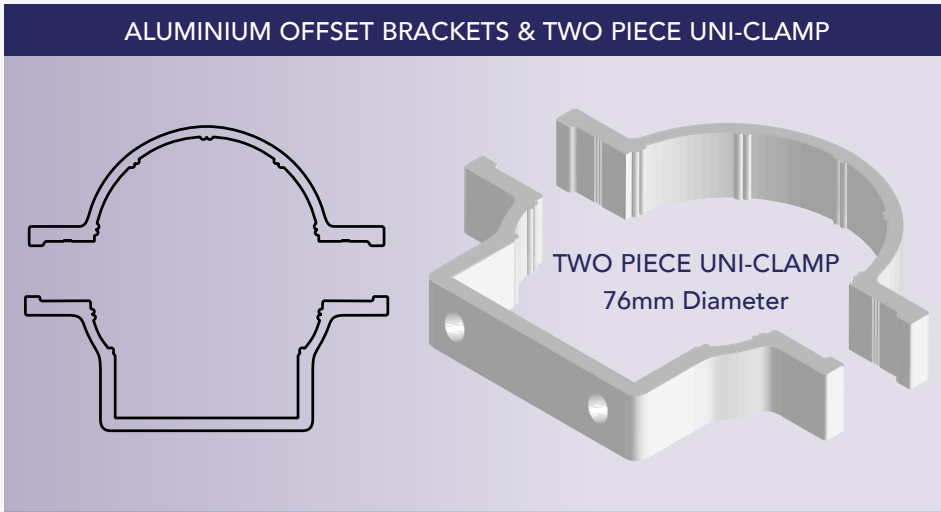

## Aluminium Offset Brackets

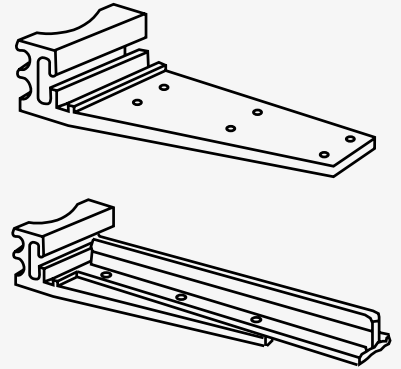

LENGTH incorporating Tee Section	PAINTED BLACK (RAL 9005)	PAINTED GREY (BS 381C/693)	MILL FINISH
200mm	■	■	■
225mm	■	■	■
300mm	■	■	■
375mm	■	■	■
450mm	■	■	■

## Complete Small Offset Bracket Assemblies

LENGTH incorporating Tee Section	PAINTED BLACK (RAL 9005)	PAINTED GREY (BS 381C/693)	MILL FINISH
200mm	■	■	■
225mm	■	■	■
300mm	■	■	■
375mm	■	■	■
450mm	■	■	■
600mm	■	■	■
750mm	■	■	■
900mm	■	■	■

## Complete Large Offset Bracket Assemblies

# Specialist Markets

Righton Blackburns fulfils the diverse and exacting requirements of multiple industries, providing commercial, high-integrity, and fully bespoke materials engineered to precise specifications. Our expertise encompasses a broad spectrum of applications, supported by many years of close collaboration with suppliers and customers across markets including:



For more information on our full product range, contact your local Service Centre to request brochures tailored to the specialist markets we serve, or download them directly from our website.

# Your trusted supply partner for quality metals and specialist plastics

Copyright 2019: All Rights reserved: Righton Blackburns Limited. No part of this publication may be reproduced, sorted in a retrieval system or transmitted in any form or by any means, electronic, mechanical, recording or otherwise without the prior written consent of the proprietor.

## Disclaimer

The information contained herein is based on our present knowledge and experience and is given in good faith. However, no liability will be accepted by the Company in respect of any action taken by any third party in reliance thereon.

As the products detailed herein may be used for a wide variety of purposes and as the Company has no control over their use, the Company specifically excludes all conditions or warranties expressed or implied by statute or otherwise as to dimensions, properties and/or their fitness for any particular purpose. Any advice given by the Company to any third party is given for that party's assistance only and without any liability on the part of the Company.

Any contract between the Company and a customer will be subject to the Company's Conditions of Sale. The extent of the Company's liabilities to any customer is clearly set out in those Conditions; a copy of which is available on request.

## Weights

All weights shown in this publication are for guidance only. They are calculated using nominal dimensions and scientifically recognised densities. Please note that in practice, the actual weight can vary significantly from the theoretical weight due to variations in manufacturing tolerances and compositions.

## Service Centres

With nine Service Centres nationwide, we operate a reliable and efficient delivery network supported by comprehensive in-house processing capabilities.

Alongside next-day delivery from locally held stock, we also supply non-standard and customer-specific materials to meet specialised requirements.

### Bedford

+44 (0)1234 684 100  
bedford@rblimited.co.uk

### Birmingham

+44 (0)1384 282 630  
birmingham@rblimited.co.uk

### Bristol

+44 (0)117 948 2600  
bristol@rblimited.co.uk

### Cardiff Sales Centre

+44 (0)1656 683 900  
cardiff@rblimited.co.uk

### Gateshead Sales Centre

+44 (0)191 338 7000  
gateshead@rblimited.co.uk

### Glasgow

+44 (0)141 646 3730  
glasgow@rblimited.co.uk

### Leeds

+44 (0)113 386 3280  
leeds@rblimited.co.uk

### Manchester

+44 (0)1942 758 800  
manchester@rblimited.co.uk

### Norwich

+44 (0)1603 243 900  
norwich@rblimited.co.uk

### Portsmouth

+44 (0)2392 623 070  
portsmouth@rblimited.co.uk

### Plymouth

+44 (0)1752 844 931  
plymouth@rblimited.co.uk

### Tonbridge Sales Centre

+44 (0)1732 582 700  
tonbridge@rblimited.co.uk



AS 9100 REV D  
AS 9120 REV B

